

DIMENSIONAL DRAWING

Type S41

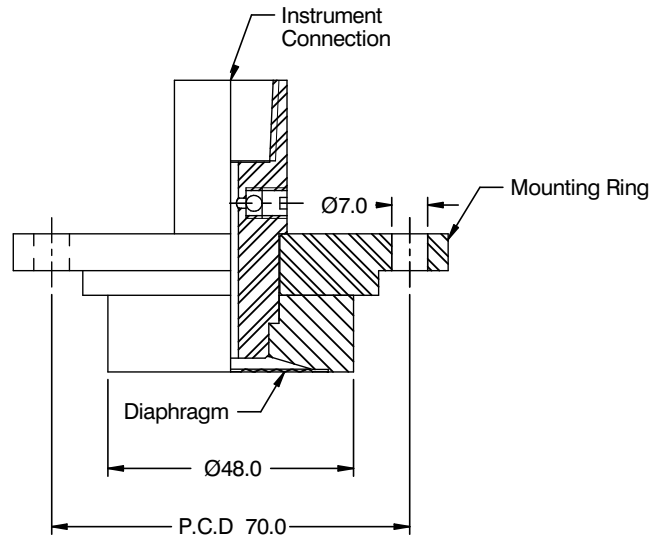

All dimensions are in mm.