

DIMENSIONAL DRAWING

Type B0

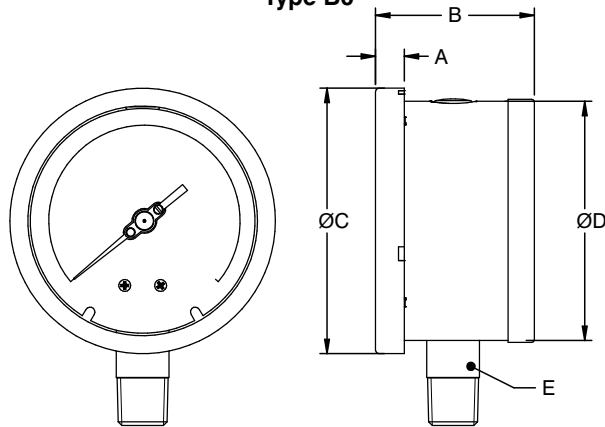

DN	A	B	ØC	ØD	E	Weight (grams)
100	12	66.5	111	100	SQ.22	830
150	17	68.5	161	149	SQ.22	1638

Type B1

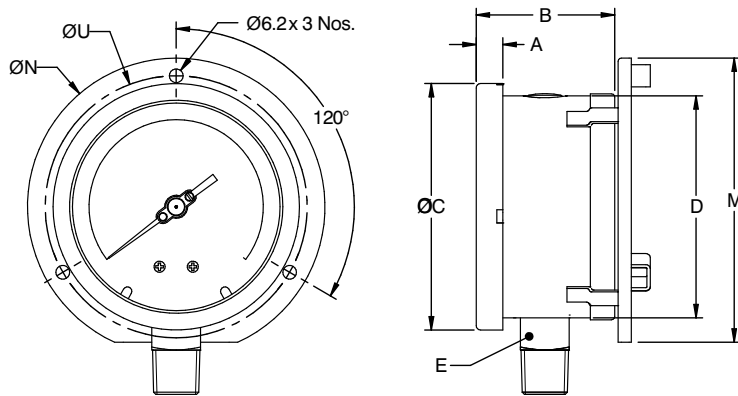

DN	A	B	ØC	ØD	E	M	ØN	ØU	Weight (grams)
100	12	66.5	111	100	SQ.22	128	134	118	909
150	17	68.5	161	149	SQ.22	172	186	168	1746

Type L1

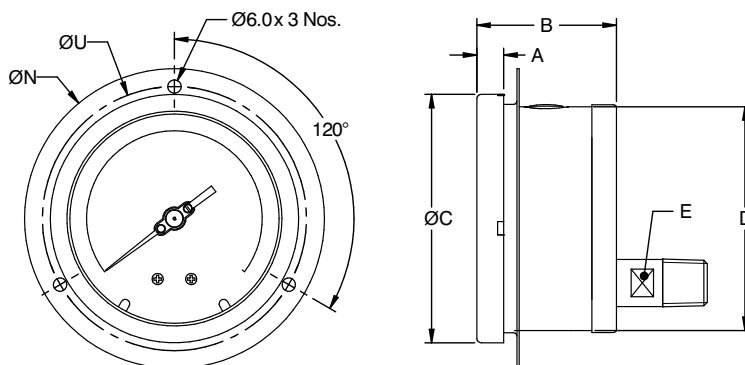

DN	A	B	ØC	ØD	E	ØN	ØU	Weight (grams)
100	12	66.5	111	100	A/F-17	134	118	906
150	17	68.5	161	149	A/F-17	186	168	1754