

DIMENSIONAL DRAWING

Type S45

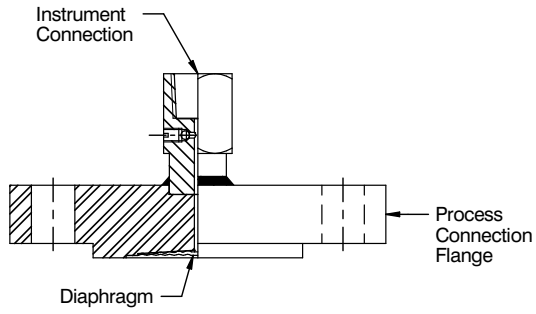

Type S46

